

Contents

1 Installing Roll Pro[®] Shutters Guide Rails	2
1.1 Take measurements for Guide Rail position.	2
1.2 Check level position of Guide Rail, and mark position.	2
1.3 Securely fasten the Guide Rails in place, as appropriate for mounting surface.	3
2 Mount Roll Pro[®] Shutters Box	3
2.1 Position Box in place.	3
2.2 Secure Box to wall, as appropriate for mounting surface.	3
2.3 Secure power cable, and connect Box to power.	4
3 Mount Roll Pro[®] Shutters Curtain	4
3.1 Lift Curtain through the back of the Box and over the Shaft.	4
3.2 Slide hangers on to the end of the Curtain.	4
3.3 Secure the Curtain to the Shaft.	5
4 Roll up Roll Pro[®] Shutters Curtain	5
4.1 (Option A) Roll up Curtain using <i>electric motor</i> .	5
4.1 (Option B) Roll up Curtain using <i>manual override</i> .	5
4.2 Guide bottom of Curtain into the Guide Rails.	6
5 Setup Roll Pro[®] Shutters Curtain limits	6
5.1 Lower Curtain with electric motor till factory default bottom limit is reached.	6
5.2 Adjust the bottom limit for proper closed curtain position.	6
5.3 Raise Curtain with electric motor till factory default upper limit is reached.	7
5.4 Adjust the upper limit for proper open curtain position.	7
6 Install Roll Pro[®] Shutters Box Cover	8
6.1 Mount and secure Box Cover.	8
6.2 Install Manual Override Assembly.	8
6.3 Remove protective plastic from Box Cover and Curtain.	8
7 Install Roll Pro[®] Shutters mounting hole covers	9
7.1 Plug any mounting hole on Guide Rails with hole covers.	9
Contact Information	10

1 Installing Roll Pro[®] Shutters Guide Rails

1.1 Take measurements for Guide Rail position.

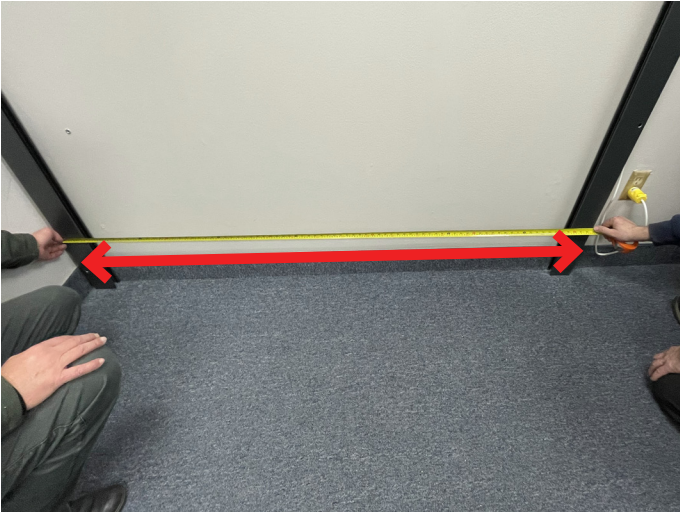

Measuring width of bottom Guide Rail position.

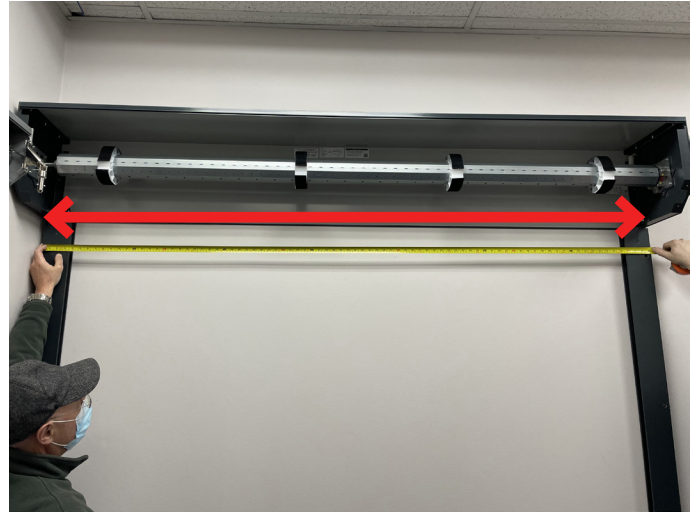

Measuring width of top Guide Rail position.



Measuring diagonal of Guide Rail position.

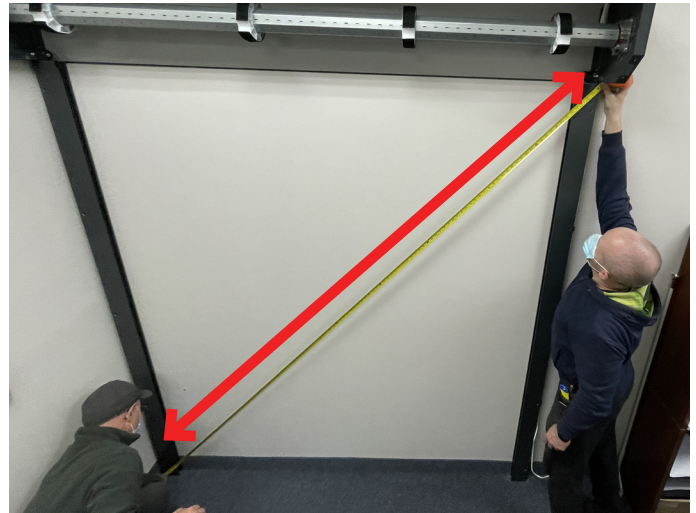

Measuring diagonal of Guide Rail position.

1.2 Check level position of Guide Rail, and mark position.



Checking level position of Guide Rails.



Marking Guide Rails position.

1.3 Securely fasten the Guide Rails in place, as appropriate for mounting surface.



Securing Guide Rails in place.

2 Mount Roll Pro[®] Shutters Box

2.1 Position Box in place.

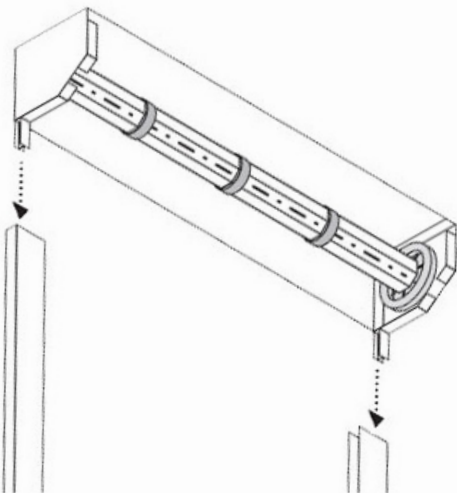

Guide the Box lugs into the Guide Rails.



Placing Box in position.

2.2 Secure Box to wall, as appropriate for mounting surface.



Securing left side of Box.



Securing right side of Box.

2.3 Secure power cable, and connect Box to power.



Securing power cable.



Power cable plugged into wall socket.

3 Mount Roll Pro[®] Shutters Curtain

3.1 Lift Curtain through the back of the Box and over the Shaft.



Lifting Curtain behind and over the Shaft.



The Curtain should be above the rollers inside the Box.

3.2 Slide hangers on to the end of the Curtain.



Slide Hangers onto the end of the Curtain.

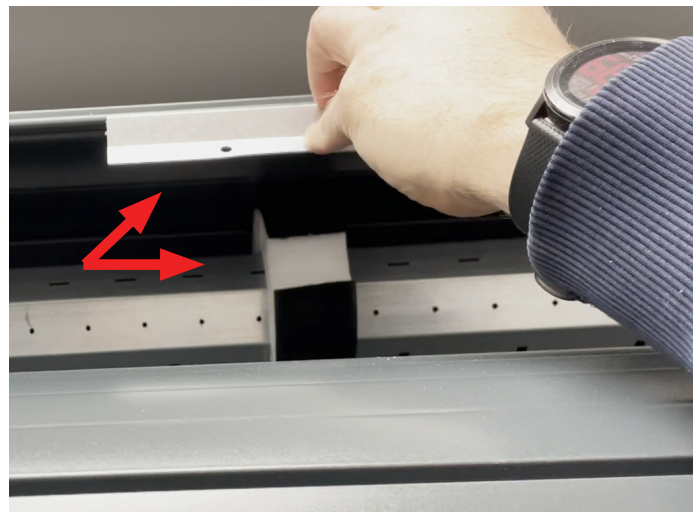

Position Hangers over the Shaft Collars.

3.3 Secure the Curtain to the Shaft.

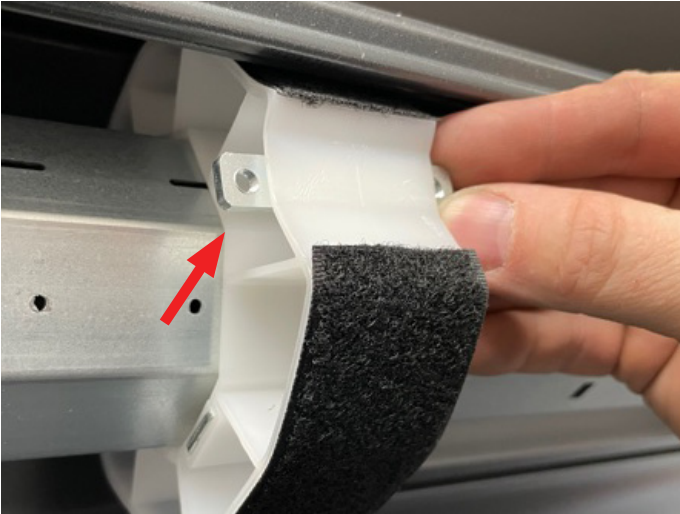

Position mounting plates behind Shaft Collar.



Secure the Hangers to the Shaft Collars.

4 Roll up Roll Pro[®] Shutters Curtain

4.1 (option A) Roll up Curtain using *electric motor*.



Use the remote to operate the electric motor.



Hold Curtain when rolling Curtain into Box.

4.1 (option B) Roll up Curtain using *manual override*.

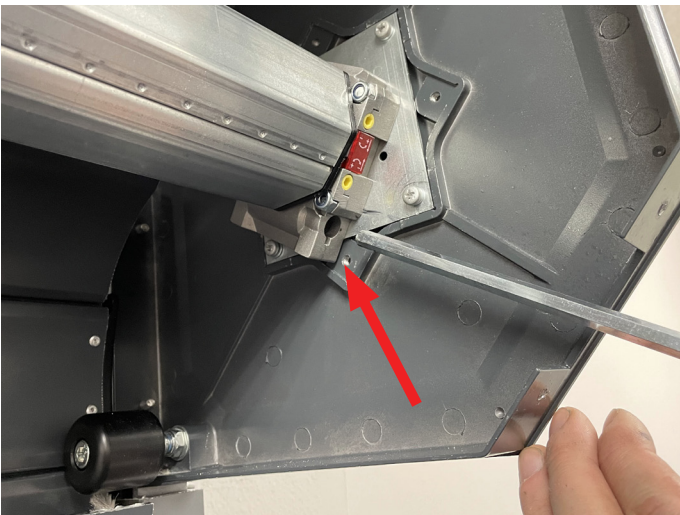

Find the Manual override port below the limit screws.



An example of tool used to operate the manual override.

4.2 Guide bottom of Curtain into the Guide Rails.



Curtain positioned to feed into Guide Rails.

5 Setup Roll Pro[®] Shutters Curtain limits

5.1 Lower Curtain with electric motor till factory default bottom limit is reached.



Use the remote to lower the curtain till it stops.



The curtain has reached its factory default bottom limit.

5.2 Adjust the bottom limit for proper closed curtain position.



Use the bottom limit screw to lower the Curtain.



Adjust lower limit till the Curtain is firmly at the bottom.



Proper position of Curtain top when bottom limit is set.



Proper position of Curtain top when bottom limit is set.

5.3 Raise Curtain with electric motor till factory default upper limit is reached.



Use the remote to raise the curtain till it stops.



The curtain has reached its factory default upper limit.

5.4 Adjust the upper limit for proper open curtain position.



Use the upper limit screw to raise the Curtain.



Adjust the upper limit till the current is positioned at top.

6 Install Roll Pro[®] Shutters Box Cover

6.1 Mount and secure Box Cover.



Mounting Box Cover in place.



Securing Box Cover.

6.2 Install Manual Override Assembly.



Installing Manual Override Assembly.



Securing Manual Override Assembly in place.

6.3 Remove protective plastic from Box Cover and Curtain.



Peeling away protective plastic from Box Cover.



Peeling off protective plastic.

7 Install Roll Pro[®] Shutters mounting hole covers

7.1 Plug any mounting hole on Guide Rails with hole covers.



Plugging up mounting hole.

More questions? Contact us:

Roll Pro[®] Shutters

2160 HWY 7, Unit #28
Concord, ON, Canada, L4K1W6

E-mail: sales@rollpro.ca

Tel: (905)-532-0017

Toll Free: 1-(855)-474-7657

Fax: (905)-532-0017